

Standard Aircraft Characteristics

NAVY MODEL UH-1N AIRCRAFT

THIS PUBLICATION IS REQUIRED FOR OFFICIAL USE OR FOR ADMINISTRATIVE OR OPERATIONAL PURPOSES ONLY. DISTRIBUTION IS LIMITED TO U.S. GOVERNMENT AGENCIES. OTHER REQUESTS FOR THIS DOCUMENT MUST BE REFERRED TO COMMANDING OFFICER, NAVAL AIR TECHNICAL SERVICES FACILITY, 700 ROBBINS AVENUE, PHILADELPHIA, PA 19111.

THIS PUBLICATION SUPERSEDES
NAVAIR 00-110AH1-3 DATED AUGUST 1974

PUBLISHED BY DIRECTION OF THE
COMMANDER OF THE NAVAL AIR SYSTEMS COMMAND

FEBRUARY 1982



STANDARD AIRCRAFT CHARACTERISTICS

UH-1N

BELL

FEBRUARY 1982

UH-1N

NAVAL AIR SYSTEMS COMMAND
NAVY DEPARTMENT

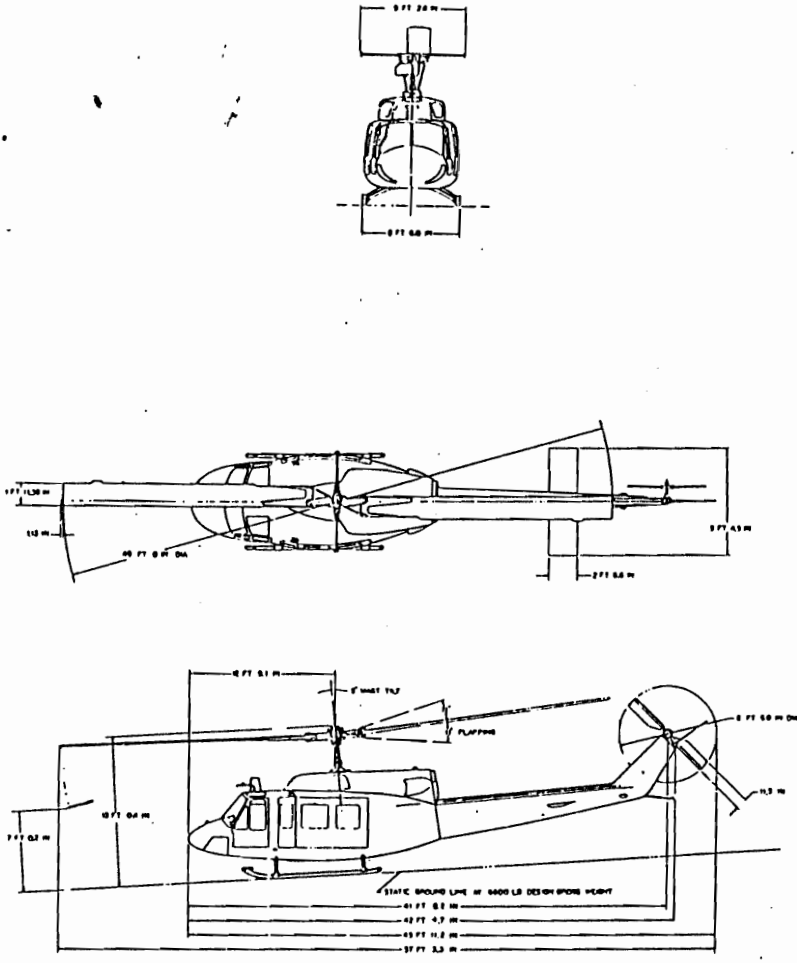

DESCRIPTIVE ARRANGEMENT

UH-1N

NAVAL AIR SYSTEMS COMMAND
NAVY DEPARTMENT

Disc Area 1809.0 sq ft
Blade Area 93.5 sq ft
Engine/Rotor Gear Ratio 20.38:1

Airfoil Section (Root to 80%)
10.8% thick; (80% to Tip) Tapers
to 5.4% thick at tip, modified
droop snoot.
Chord (Root to Tip)=23 3/8 in

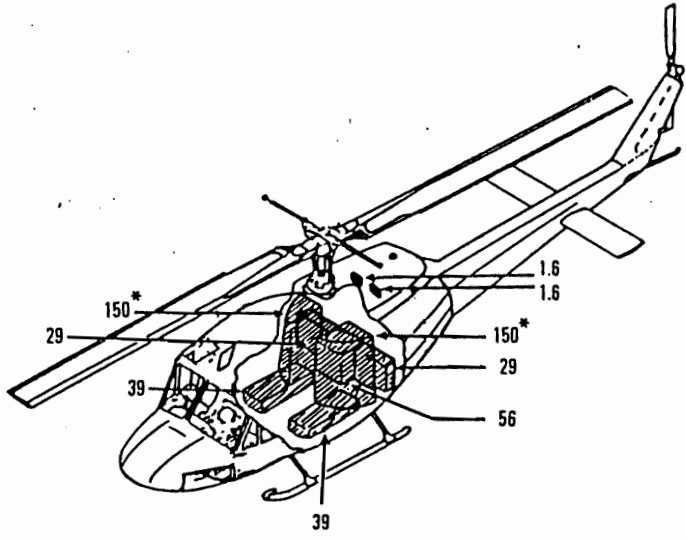

FUEL (GAL) *Auxiliary fuel tanks OIL (GAL)
Crashworthy Non-crashworthy

ARMAMENT AND TANKAGE

2

FEBRUARY 1982

POWER PLANT	MISSION AND DESCRIPTION	WEIGHTS																																																						
<p>No. & Model (1) T400-CP-400 Manufacturer United Aircraft of Canada (Pratt and Whitney) Engine Spec. No. 712 C Type Twin Section Free Power Turbine with Reduction Gearbox</p> <p>Gear Reduction Ratios Main Rotor..... 20.383:1 Tail Rotor..... 3.974:1</p> <p style="text-align: center;">RATINGS</p> <table border="0"> <tr> <td></td> <td>- SHP</td> <td>RPM</td> <td>ALT</td> </tr> <tr> <td>Intermediate</td> <td>1800</td> <td>6600</td> <td>SL</td> </tr> <tr> <td>Maximum Continuous</td> <td>1530</td> <td>6600</td> <td>SL</td> </tr> <tr> <td colspan="4" style="text-align: center;">Single Power Section</td> </tr> <tr> <td>Intermediate</td> <td>900</td> <td>6600</td> <td>SL</td> </tr> <tr> <td>Maximum Continuous</td> <td>765</td> <td>6600</td> <td>SL</td> </tr> <tr> <td colspan="4" style="text-align: center;">Transmission Limits</td> </tr> <tr> <td>Intermediate</td> <td>1290 SHP</td> <td></td> <td></td> </tr> <tr> <td>Maximum Continuous</td> <td>1134 SHP</td> <td></td> <td></td> </tr> </table>		- SHP	RPM	ALT	Intermediate	1800	6600	SL	Maximum Continuous	1530	6600	SL	Single Power Section				Intermediate	900	6600	SL	Maximum Continuous	765	6600	SL	Transmission Limits				Intermediate	1290 SHP			Maximum Continuous	1134 SHP			<p>The basic missions of the UH-1N are visual observation and target acquisition, reconnaissance and command control. The UH-1N is capable of flight from established airfields, carriers of the LPN and CVS class, advanced based, ares or ships with individual landing platforms or limited landing facilities, and from unprepared fields. It may be handled on carrier elevators without any folding of components.</p> <p>In addition, the UH-1N may be used for medical evacuation, to transport personnel, special teams or crews, equipment and supplies. These missions may be performed under instrument operations including light icing and day or night flight.</p> <p>The twin power section installation improves both hot day and altitude performance.</p> <p>The semi-monocoque fuselage is of all metal construction as are the tail rotor blades and the two main rotor blades. The large sliding door along each side allows rapid entry and exit and simplified straight-through loading from either side or both sides simultaneously. The knee-high cargo floor also contributes to loading ease.</p>	<table border="1"> <thead> <tr> <th>Loading</th> <th>Weight</th> <th>L.F.</th> </tr> </thead> <tbody> <tr> <td>Empty</td> <td>6370</td> <td></td> </tr> <tr> <td>Basic</td> <td>6455</td> <td></td> </tr> <tr> <td>Operating</td> <td>6877</td> <td></td> </tr> <tr> <td>Design</td> <td>6600</td> <td>3.0</td> </tr> <tr> <td>Maximum Takeoff</td> <td>10,000*</td> <td>1.9</td> </tr> </tbody> </table> <p>*10,500 lb. for external load</p>	Loading	Weight	L.F.	Empty	6370		Basic	6455		Operating	6877		Design	6600	3.0	Maximum Takeoff	10,000*	1.9
	- SHP	RPM	ALT																																																					
Intermediate	1800	6600	SL																																																					
Maximum Continuous	1530	6600	SL																																																					
Single Power Section																																																								
Intermediate	900	6600	SL																																																					
Maximum Continuous	765	6600	SL																																																					
Transmission Limits																																																								
Intermediate	1290 SHP																																																							
Maximum Continuous	1134 SHP																																																							
Loading	Weight	L.F.																																																						
Empty	6370																																																							
Basic	6455																																																							
Operating	6877																																																							
Design	6600	3.0																																																						
Maximum Takeoff	10,000*	1.9																																																						
<p style="text-align: center;">ELECTRONICS</p> <table border="0"> <tr> <td>VHF-FM Radio Set</td> <td>AN/ARC-114</td> </tr> <tr> <td>Altimeter Encoder</td> <td>AAU-21/A</td> </tr> <tr> <td>UHF-AH Radio Set</td> <td>AN/ARC-116</td> </tr> <tr> <td>Communication Sys</td> <td>C-6533/ARC</td> </tr> <tr> <td>Gyromag Compass Set</td> <td>AN/ASN-43()</td> </tr> <tr> <td>UHF Dir Find Sys</td> <td>AN/ARA-50</td> </tr> <tr> <td>TACAN Navigation Set</td> <td>AN/ARN-105</td> </tr> <tr> <td>Transponder Set</td> <td>AN/APX-72</td> </tr> <tr> <td>HF Radio Set</td> <td>AN/ARC-102</td> </tr> <tr> <td>Auto Direc Finder</td> <td>AN/ARN-89</td> </tr> <tr> <td>Radar Altimeter</td> <td>AN/APN-171(V)</td> </tr> <tr> <td>Transponder Test Set</td> <td>TS-1843A/APX</td> </tr> </table> <p style="text-align: center;">PROVISIONS FOR</p> <table border="0"> <tr> <td>Loudspeaker System Kit</td> <td></td> </tr> <tr> <td>Commun Security Set</td> <td>TSEC/KY-28</td> </tr> <tr> <td>VHF-AH Radio Set</td> <td>AN/ARC-115</td> </tr> <tr> <td>Mark XII Computer</td> <td>KIT-1A/TSEC</td> </tr> </table>	VHF-FM Radio Set	AN/ARC-114	Altimeter Encoder	AAU-21/A	UHF-AH Radio Set	AN/ARC-116	Communication Sys	C-6533/ARC	Gyromag Compass Set	AN/ASN-43()	UHF Dir Find Sys	AN/ARA-50	TACAN Navigation Set	AN/ARN-105	Transponder Set	AN/APX-72	HF Radio Set	AN/ARC-102	Auto Direc Finder	AN/ARN-89	Radar Altimeter	AN/APN-171(V)	Transponder Test Set	TS-1843A/APX	Loudspeaker System Kit		Commun Security Set	TSEC/KY-28	VHF-AH Radio Set	AN/ARC-115	Mark XII Computer	KIT-1A/TSEC	<p style="text-align: center;">DEVELOPMENT</p> <table border="0"> <tr> <td>Contract Placement</td> <td>September 1969</td> </tr> <tr> <td>First Flight (Comm. 212)</td> <td>April 1969</td> </tr> <tr> <td>(USAF UH-1N)</td> <td>March 1970</td> </tr> <tr> <td>(USN UH-1N)</td> <td>January 1971</td> </tr> <tr> <td>First Delivery</td> <td>March 1971</td> </tr> </table>	Contract Placement	September 1969	First Flight (Comm. 212)	April 1969	(USAF UH-1N)	March 1970	(USN UH-1N)	January 1971	First Delivery	March 1971	<p style="text-align: center;">FUEL AND OIL</p> <p style="text-align: center;">FUEL</p> <table border="0"> <tr> <td>Gal.</td> <td>No. of Tanks</td> <td>Locations</td> </tr> <tr> <td>191.9*</td> <td>5</td> <td>Fuselage</td> </tr> <tr> <td>300.0</td> <td>2</td> <td>Cabin</td> </tr> </table> <p>Fuel Grade.....JP-4/JP-5/JP-8 Fuel Spec.....MIL-J-5624</p> <p>*Crashworthy Fuel System</p> <p style="text-align: center;">OIL</p> <p>Engine (Gal.)..... 3.2 Spec.....MIL-L-23699</p>	Gal.	No. of Tanks	Locations	191.9*	5	Fuselage	300.0	2	Cabin			
VHF-FM Radio Set	AN/ARC-114																																																							
Altimeter Encoder	AAU-21/A																																																							
UHF-AH Radio Set	AN/ARC-116																																																							
Communication Sys	C-6533/ARC																																																							
Gyromag Compass Set	AN/ASN-43()																																																							
UHF Dir Find Sys	AN/ARA-50																																																							
TACAN Navigation Set	AN/ARN-105																																																							
Transponder Set	AN/APX-72																																																							
HF Radio Set	AN/ARC-102																																																							
Auto Direc Finder	AN/ARN-89																																																							
Radar Altimeter	AN/APN-171(V)																																																							
Transponder Test Set	TS-1843A/APX																																																							
Loudspeaker System Kit																																																								
Commun Security Set	TSEC/KY-28																																																							
VHF-AH Radio Set	AN/ARC-115																																																							
Mark XII Computer	KIT-1A/TSEC																																																							
Contract Placement	September 1969																																																							
First Flight (Comm. 212)	April 1969																																																							
(USAF UH-1N)	March 1970																																																							
(USN UH-1N)	January 1971																																																							
First Delivery	March 1971																																																							
Gal.	No. of Tanks	Locations																																																						
191.9*	5	Fuselage																																																						
300.0	2	Cabin																																																						
	<p style="text-align: center;">DIMENSIONS</p> <table border="0"> <tr> <td>Rotor Diameter</td> <td>48.0'</td> </tr> <tr> <td>Length</td> <td></td> </tr> <tr> <td> Rotors Operating</td> <td>57.3'</td> </tr> <tr> <td> Rotors Static</td> <td>57.3</td> </tr> <tr> <td> Fuselage</td> <td>42.4'</td> </tr> <tr> <td>Span (Max Lateral)</td> <td>9.2'</td> </tr> <tr> <td>Height</td> <td>14.9'</td> </tr> <tr> <td>Tread</td> <td>8.5'</td> </tr> <tr> <td>Ground Clearance</td> <td>7.0'</td> </tr> <tr> <td>(Static, Against Stops)</td> <td></td> </tr> </table>	Rotor Diameter	48.0'	Length		Rotors Operating	57.3'	Rotors Static	57.3	Fuselage	42.4'	Span (Max Lateral)	9.2'	Height	14.9'	Tread	8.5'	Ground Clearance	7.0'	(Static, Against Stops)		<p style="text-align: center;">ORDNANCE</p> <p style="text-align: center;">ACCOMMODATIONS</p> <table border="0"> <tr> <td>Crew (Observation).....</td> <td>4</td> </tr> <tr> <td>Cabin Size Clearance:</td> <td></td> </tr> <tr> <td> Length (Overall)</td> <td>7.8'</td> </tr> <tr> <td> Width (Maximum)</td> <td>7.7'</td> </tr> <tr> <td> Height (Maximum)</td> <td>4.1'</td> </tr> <tr> <td>Usable Volume</td> <td></td> </tr> <tr> <td> Cargo Area 220 Cu-ft</td> <td></td> </tr> <tr> <td> Copilot Area 20 Cu-ft</td> <td></td> </tr> <tr> <td>Provision for Troop Seats.....</td> <td>8</td> </tr> <tr> <td>Provision for Litters.....</td> <td>6</td> </tr> <tr> <td>Cargo Hook Capacity.....</td> <td>5,000 lb</td> </tr> <tr> <td>Limit Floor Loading</td> <td>100 lb/sq.ft.</td> </tr> <tr> <td></td> <td>at L.F. 3.5</td> </tr> </table>	Crew (Observation).....	4	Cabin Size Clearance:		Length (Overall)	7.8'	Width (Maximum)	7.7'	Height (Maximum)	4.1'	Usable Volume		Cargo Area 220 Cu-ft		Copilot Area 20 Cu-ft		Provision for Troop Seats.....	8	Provision for Litters.....	6	Cargo Hook Capacity.....	5,000 lb	Limit Floor Loading	100 lb/sq.ft.		at L.F. 3.5								
Rotor Diameter	48.0'																																																							
Length																																																								
Rotors Operating	57.3'																																																							
Rotors Static	57.3																																																							
Fuselage	42.4'																																																							
Span (Max Lateral)	9.2'																																																							
Height	14.9'																																																							
Tread	8.5'																																																							
Ground Clearance	7.0'																																																							
(Static, Against Stops)																																																								
Crew (Observation).....	4																																																							
Cabin Size Clearance:																																																								
Length (Overall)	7.8'																																																							
Width (Maximum)	7.7'																																																							
Height (Maximum)	4.1'																																																							
Usable Volume																																																								
Cargo Area 220 Cu-ft																																																								
Copilot Area 20 Cu-ft																																																								
Provision for Troop Seats.....	8																																																							
Provision for Litters.....	6																																																							
Cargo Hook Capacity.....	5,000 lb																																																							
Limit Floor Loading	100 lb/sq.ft.																																																							
	at L.F. 3.5																																																							

PERFORMANCE SUMMARY

TAKE-OFF LOADING CONDITION	① OBSERVATION	② RESCUE	③ MEDICAL EVACUATION	④ TROOP TRANSPORT	⑤ EXTERNAL TRANSPORT	⑥ FERRY
TAKE-OFF WEIGHT lb.	8582	8740	8622	9982	10500	10000
Fuel internal/external (JP-5) lb./lb.	1305/0	1305/0	1305/0	1305/0	1305/0	3010
Payload OUT/ RETURN lb.	0/0	0/200	0/1200	1800/0	2318/0	0/0
Disc loading lb./sq. ft.	4.74	4.83	4.77	5.52	5.80	5.53
Vertical rate of climb at S.L. (A) fpm.	1855	1720	1835	800	425	810
Absolute hovering ceiling (OGE) (A) ft.	14000	13400	13900	9200	5200	9250
Max. rate of climb at S.L. (A) fpm.	2450	2400	2440	1730	1600	1750
Service ceiling (A) ft.	21600	21200	21500	18000	16900	18100
Speed at S.L. (B) kn.	121	119	121	109	106	109
Max speed/altitude (B) kn./ft.	125/3500	123/3500	125/3500	113/3000	111/3000	113/3000
O.E.I. Service ceiling (A) ft.	14200	13800	14100	10500	9200	10600
Min. speed (O.E.I.) (A),(D) kn.	14	15	14	24	26	24
Max. speed (O.E.I.) (A), (D), (E) kn.	110	109	110	102	98	102
Combat radius n. mi.	81	72	85	82	70	-
Mission time hrs.	1.48	1.54	1.62	1.45	1.60	-
Average cruising speed kn.	124	124	120	123	98	-
Cruising altitude ft.	SL	SL	5000	SL	SL	-
Range n. mi.	172	171	190	165	131	491
Average cruising speed kn.	124	124	121	115	80	118
Cruising altitude ft.	SL	SL	5000	SL	SL	2000 to 10000
Maximum endurance (C) hrs.	2.00	2.00	2.25	1.93	1.74	5.87
Endurance speed kn.	56	56	57	59	50	58
Endurance altitude ft.	SL	SL	5000	SL	SL	2000 to 10000

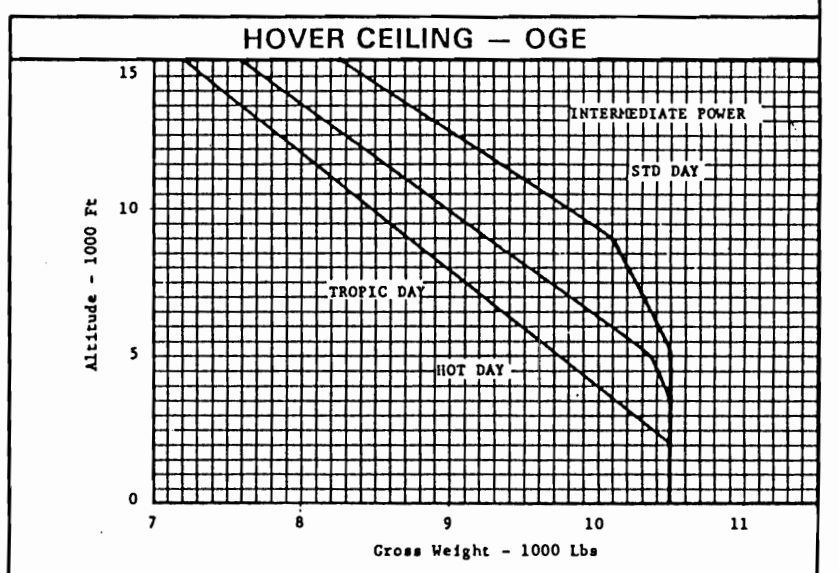
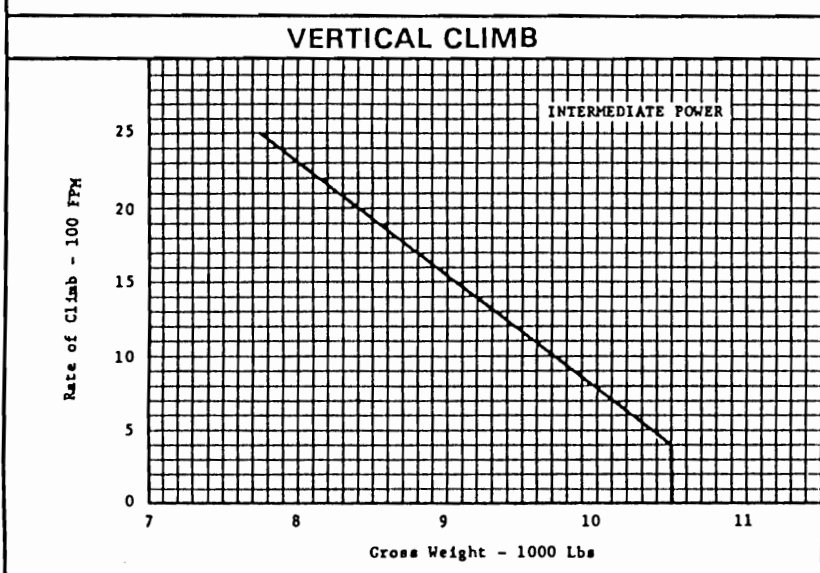
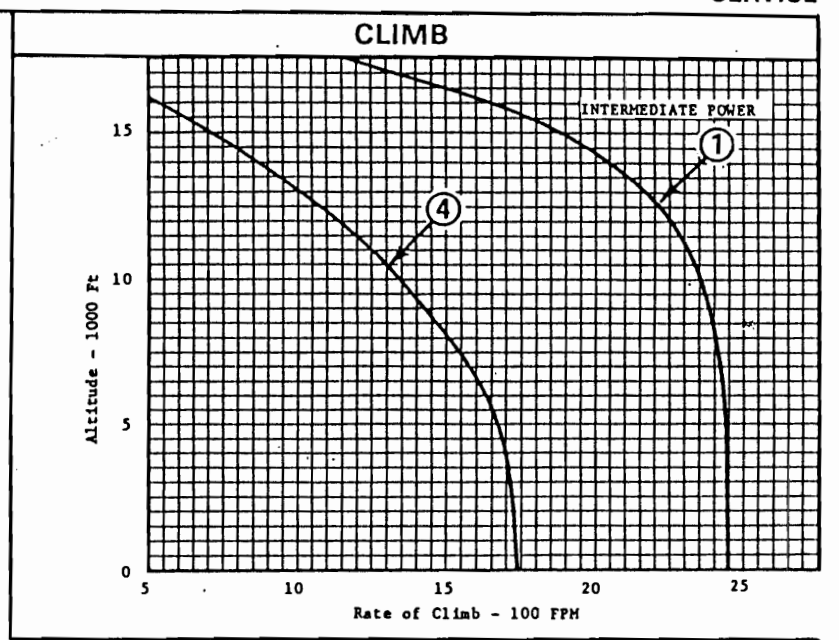
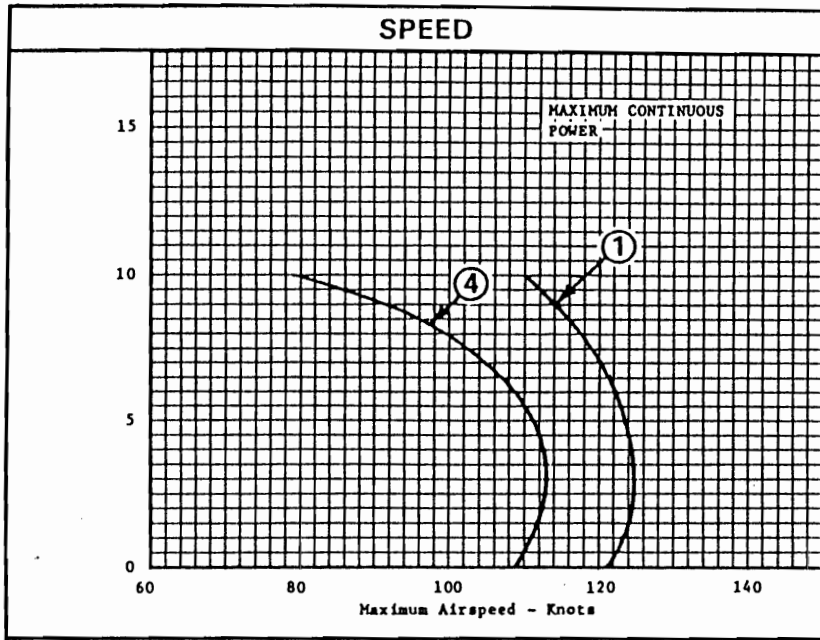

NOTES

- (A) At intermediate power or 1290 hp take-off transmission limit.
- (B) At V_{NE} .
- (C) Endurance time excludes engine start and take-off, climb to altitude, and reserve.
- (D) At sea level.
- (E) At maximum continuous power.
- (F) All performance at standard day conditions.
- (G) Engine specification fuel flow increased 5%.
- (H) Data basis: UH-1N and Model 212 flight test.

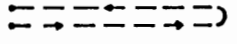
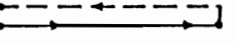
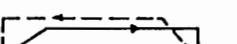
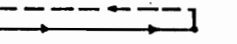
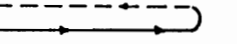

○ LOADING CONDITION COLUMN NUMBER

NOTES

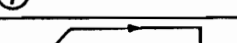
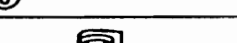
① OBSERVATION	② RESCUE	③ MEDICAL EVACUATION	④ TROOP TRANSPORT	⑤ EXTERNAL TRANSPORT	⑥ FERRY
 <ol style="list-style-type: none"> 1. Warm-up and take-off: Fuel allowance of 5 minutes at maximum continuous power at sea level. 2. Cruise out: At speed for best range at sea level. 3. Hover: 5 minutes out of ground effect at mid-mission. 4. Cruise back: To home base at speed for best range at sea level. 5. Landing reserve: Fuel for 20 minutes at speed for maximum range at sea level. 	 <ol style="list-style-type: none"> 1. Warm-up and take-off: Fuel allowance of 5 minutes at maximum continuous power at sea level. 2. Dash out: To target at maximum cruise speed for maximum continuous power at sea level. 3. Search: Over target at speed for best endurance for 15 minutes at sea level. 4. Pick up survivor: Hover out of ground effect 2 minutes at sea level. 5. Cruise back: To base at speed for maximum range at sea level. 6. Landing reserve: Fuel for 20 minutes at speed for maximum range at sea level. 	 <ol style="list-style-type: none"> 1. Warm-up and take-off: Fuel allowance 5 minutes at maximum continuous power. 2. Climb out: On course at speed for best climb at intermediate power to 5000 feet. 3. Cruise out: To remote base at 5000 feet at maximum continuous power. 4. Descend to sea level: No fuel used, no distance gained. 5. Land, pick up six (6) litter patients: Mid-point fuel allowance of 2 minutes at maximum continuous power at sea level. 6. Climb back: On course at best climb speed at maximum continuous power to 5000 feet. 7. Cruise back: To home base at 5000 feet at maximum continuous power. 8. Descend to sea level: No fuel used, no distance gained. 9. Landing reserve: Fuel for 20 minutes at speed for maximum range at sea level. 	 <ol style="list-style-type: none"> 1. Warm-up and take-off: Fuel allowance of 5 minutes at maximum continuous power at sea level. 2. Cruise out: To remote base at maximum continuous power at sea level. 3. Land and unload troops: Mid-point fuel allowance of 2 minutes at maximum continuous power at sea level. 4. Cruise back: To home base at maximum continuous power at sea level. 5. Landing reserve: Fuel for 20 minutes at speed for maximum range at sea level. 	 <ol style="list-style-type: none"> 1. Warm-up and take-off: Fuel allowance of 5 minutes at maximum continuous power at sea level. 2. Cruise out: To remote base with payload at 80 knots at sea level. 3. Hover: 5 minutes out of ground effect at sea level with payload. 4. Release payload. 5. Cruise back: To home base without payload at speed for best range at sea level. 6. Landing reserve: Fuel for 20 minutes at speed for maximum range at sea level. 	 <ol style="list-style-type: none"> 1. Warm-up and take-off: Fuel allowance of 5 minutes at maximum continuous power at sea level. 2. Climb out: On course at best climb speed at intermediate power to optimum cruise altitude not to exceed 10,000 feet (unless limited by cruise ceiling). 3. Cruise out: To remote base at speed for maximum range at optimum cruise altitude not to exceed 10,000 feet (unless limited by cruise ceiling). 4. Descend to sea level: No fuel used, no distance gained. 5. Landing reserve: Fuel for 30 minutes at speed for maximum range at sea level.
<p>⑦ RANGE MISSION</p>  <ol style="list-style-type: none"> 1. Warm-up and take-off: Fuel allowance of 5 minutes at maximum continuous power at sea level. 2. Climb to specified cruise altitude at best climb speed at maximum continuous power. 3. Cruise out to remote base at speed for maximum range at specified altitude. 4. Landing reserve: 10X of initial fuel or fuel for 20 minutes at speed for maximum range at sea level, whichever is greater. 	<p>⑧ ENDURANCE MISSION</p>  <ol style="list-style-type: none"> 1. Warm-up and take-off: Fuel allowance of 5 minutes at maximum continuous power at sea level. 2. Climb to specified cruise altitude at best climb speed at maximum continuous power. 3. Loiter at speed for minimum fuel flow at specified altitude. 4. Landing reserve: 10X of initial fuel or fuel for 20 minutes at speed for maximum range at sea level, whichever is greater. 	<p>○ LOADING CONDITION COLUMN NUMBER</p>			